

PROPRIETARY INFORMATION

THIS DRAWING IS THE CONFIDENTIAL PROPERTY OF AMERI-SHRED CORP. AND IS TRANSMITTED IN CONFIDENCE. THE REPRODUCTION, USE OR DISCLOSURE, IN WHOLE OR IN PART, OF THE DESIGN OR DETAILS CONTAINED HEREIN IS PROHIBITED WITHOUT THE EXPRESS WRITTEN PERMISSION OF AMERI-SHRED CORP.

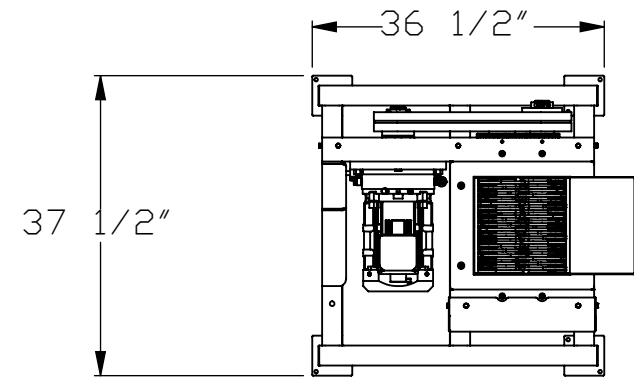

MWS-21003
 NUMBER OF MOTORS: 1
 DRIVE: 5 HP ELECTRIC
 VOLTAGE: 460V, 3PH, 60HZ
 CUTTING CHAMBER: 12"W X 12"L
 WEIGHT: 1200-1300 LBS SYSTEM TOTAL

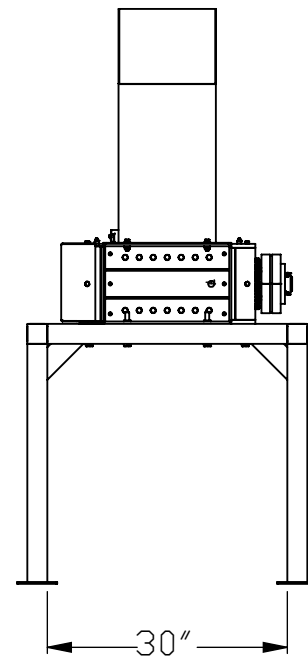
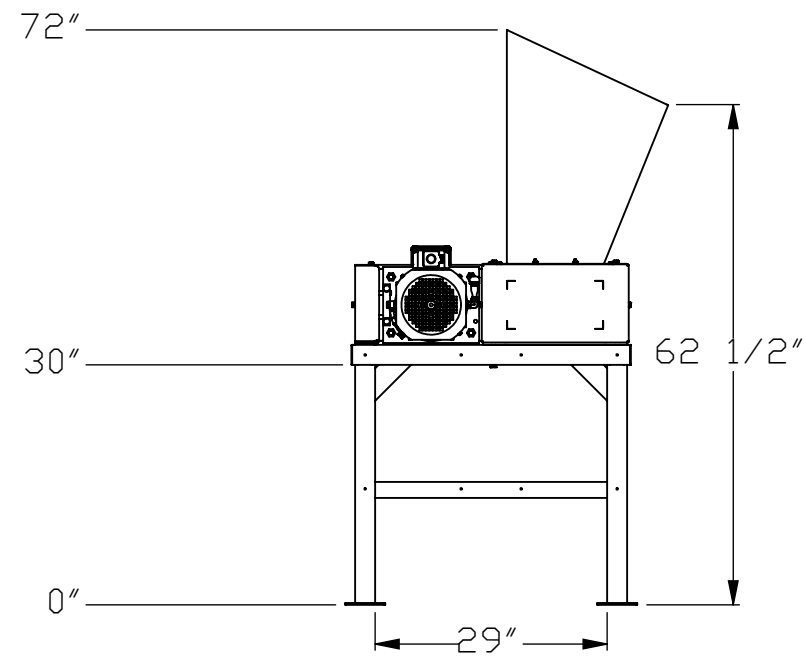
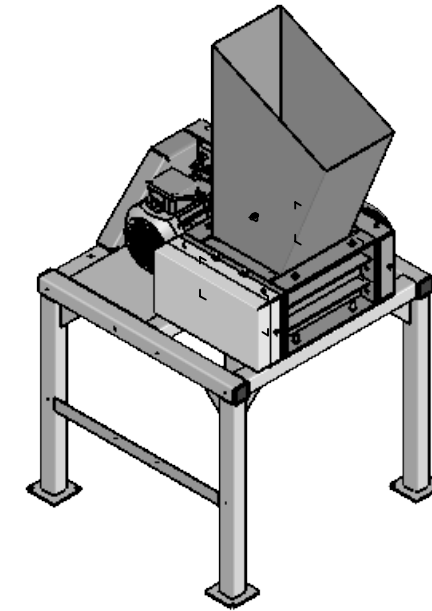

SAFETY REVIEW

THE NEED FOR SAFETY DEVICES VARIES WITH EACH APPLICATION OF THIS PRODUCT. THIS DRAWING MAY NOT INCLUDE ALL APPROPRIATE SAFETY DEVICES FOR YOUR APPLICATION. AS SYSTEMS INTEGRATOR, PLEASE ADVISE YOUR CUSTOMER OF DEVICES THAT ARE APPROPRIATE FOR HIS/HER APPLICATION, BASED ON YOUR SAFETY ASSESSMENT. DEVICES MAY INCLUDE, BUT ARE NOT LIMITED TO THOSE SUCH AS, ADDITIONAL GUARDING, SAFETY CONTROLS, BARRICADES, END STOPS, ETC. COMPLIANCE WITH FEDERAL, STATE, OSHA AND LOCAL LAWS OR CODES ARE THE RESPONSIBILITY OF BOTH YOU, AS THE SYSTEMS INTEGRATOR/DISTRIBUTOR, AND THE END USER.

APPLICATION REVIEW

PLEASE REVIEW THE MACHINE DESIGN FOR ITS ABILITY TO FUNCTION PROPERLY IN YOUR INTENDED APPLICATION. SYSTEM INTEGRATION AND APPLICATION REVIEW ARE NOT THE RESPONSIBILITY OF AMERI-SHRED CORP THEREFORE, AMERI-SHRED CORP. MAKES NO CLAIM AS TO THE PERFORMANCE OF THIS DESIGN FOR ANY PARTICULAR PURPOSE OR APPLICATION.

SALES DRAWING

AMERI-SHRED CORP.

PAINT COLOR:

DRAWN BY: JEB

SCALE: N/A

TITLE: MWS-21003/5 SALES DWG

SALES DWG

DATE: 10/23/2019 2:39:25 PM